



BARFLY

STOOL

COMFORTABLE
AND
SUPPORTIVE.
THE BEST
IN A
DRINKING PARTNER.



BARFLY

STOOL

DESCRIPTION

The Barfly stool is constructed from solid ash wood, with a visual play of the contrast between the round legs and square seat. The Barfly can be ordered in matte colour lacquer, our stain colours or matte natural finish.

OMSCHRIJVING

De Barfly kruk is gemaakt van massief essenhout, waarbij het onderstel is samengesteld uit rondhout met daarop een contrasterende rechte zitting met lende steun. De Barfly kan worden afgewerkt met blanke lak, een kleurlak of beits.

Design Neil David Coppens

DIMENSIONS in CM / INCH

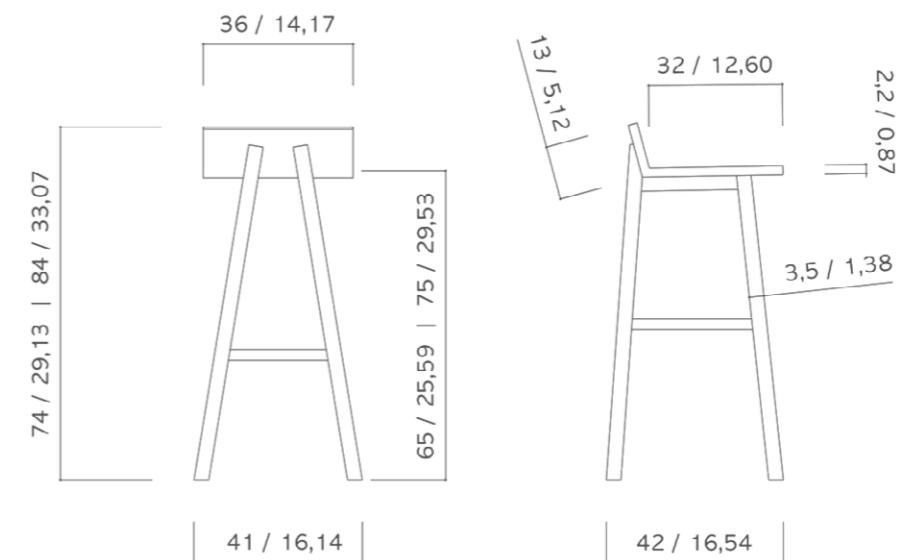



7034
yellow grey
geel grijs

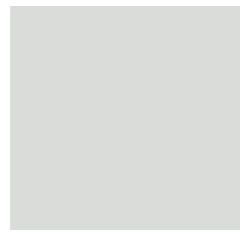

7035
light grey
licht grijs



1016
yellow
geel



9011
black
zwart

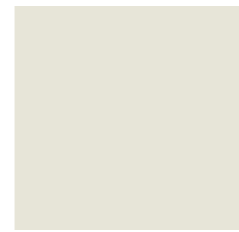

1013
oyster white
parel wit



6004
blue green
blauw groen



5002
ultra blue
ultra blauw



5024
light blue
licht blauw



5003
dark blue
dark blauw



9010
white
wit

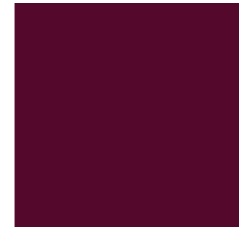

3004
purple red
paars rood



3020
red
rood



2002
orange
oranje

MATTE COLOUR LACQUERS

The matte finish does not influence the true colour of the lacquer.

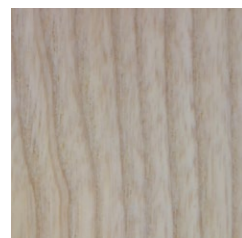

natural
blank

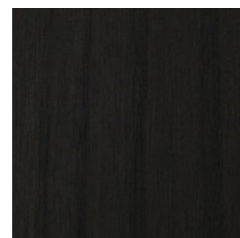

black
zwart

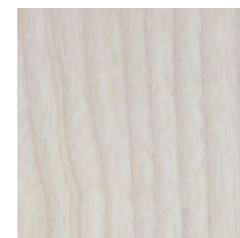

white
wit

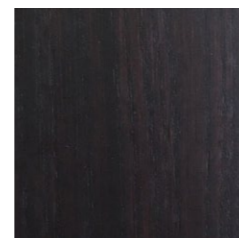

brown
bruin

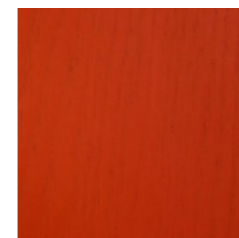

orange
oranje

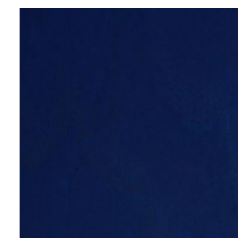

blue
blauw

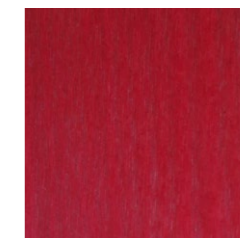

red
rood



yellow
geel

ASH WOOD STAINS

Stain options accentuate the structure of the ash wood, while a matte lacquer finish allows the texture of the grain to show through a denser colour coverage.

Please be advised that the colours on these pages are printed and therefore may differ slightly from the original.

Made in

the Netherlands

More information?

NEIL DAVID B.V.
info@neildavid.com
neildavid.com
+31 622555118

Neil David has the right to change both the design, material and/or dimensions from what is published here with no obligation.

Neil David heeft het recht om veranderingen aan te brengen in zowel ontwerp als materiaal en afmetingen in tegenstelling tot wat er gepubliceerd is zonder waarschuwing.

**Thank
you.**